

CYGNETT

RoamPWR 1,000W/ 614.4Wh Portable Power Station

CY5868CYPPS



Unlock helpful tips, safety info, and everything
you need to get the most out of your new
Power Station.

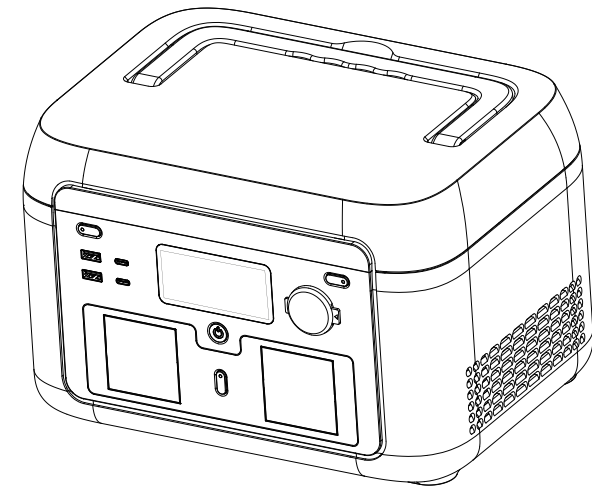

User Manual

Cygnett Pty Ltd 858 Lorimer St, Port Melbourne, Victoria 3207 Australia

Cygnett USA Inc 3838 W Carson St, Ste 220, Torrance, CA 90503

Cygnett UK Ltd 71-75 Shelton St, London, WC2H 9JQ

Cygnett NZ Ltd Level 9, 45 Queen Street, Auckland 1010

Cygnett EU Authorised Representative 24hour-AR, Van Nelleweg
1, 3044 BC Rotterdam, The Netherlands

Content

1. Parameters	1
2. Safety guidelines	
2.1 Warning	2
2.2 Discard	3
3. Guideline for users	
3.1 Product overview	3
3.2 LCD screen	4
3.3 Use	5
3.4 AC charging	7
3.5 PV charging	7
3.6 Car charging	8
3.7 Battery expansion	8
3.8 Constant power	11
3.9 APP	12
3.10 EPS function	
4. FAQs (Frequently Asked Questions)	13
5. Error messages & solutions	13
6. What's in the box	16
7. Maintenance	16
8. Disclaimer	17

Parameters

General

Item No	CY5868CYPPS
Product Name	RoamPWR 1,000Wh / 614.4Wh Portable Power Station
Net weight	≈8.5kg (≈18.7lbs)
Dimension	301x227x193mm (11.8x8.9x7.6in)
Battery capacity	614.4Wh, 51.2V \approx , 12Ah
Wi-Fi	supported

Output

(UK/EU/FR/AU/ZA)

AC socket x2 (Inverter mode)	pure sine-wave, total 1000W (peak 1600W), 220-240V~, 50Hz/60Hz, 5A
AC socket (Bypass mode)	220-240V~, 50Hz/60Hz, 1000W Max., 5A

(US)

AC socket x2 (Inverter mode)	pure sine-wave, total 1000W (peak 1600W), 100-120V~, 60Hz, 10A
AC socket (Bypass mode)	100-120V~, 60Hz, 1000W Max., 10A

USB-A1+A2 5V \approx 2.4A, 12W Max.

USB-C1/C2 5/9/12/15V \approx 3A, 20V \approx 5A, 100W Max.

Car charger 12.6V \approx 10A, 126W Max.

* Inverter mode: the output AC power comes from the battery, not the grid.

* Bypass mode: the output AC power comes from the grid, not the battery.

Input

(UK/EU/FR/AU/ZA)

AC input power 1500W Max., 7.5A

AC input voltage 220-240V~, 50Hz/60Hz

(US)

AC input power 1500W Max., 15A

AC input voltage 100-120V~, 60Hz

PV charge 13-45V \approx 12A, 400W Max.

Car charging input 12V/24V battery supported, 5A by default

Adapter input 21V \approx 5A, 105W Max.

Input charging

AC charging power 700W Max.

PV / Car charging power 400W Max.

AC+PV charging power 700W Max.

Battery

Cell Type	lithium iron phosphate battery (LiFePO ₄)
Life cycle	3000 cycles
Protection type	over temperature protection, low temperature protection, over discharge protection, over charge protection, over load protection, short circuit protection, over current protection

*Test conditions: 95% DOD, 0.5C charge & 1.0C discharge at +25±3°C.

Operating temperature

Optimal operating temperature	20°C~30°C (68°F~86°F)
Discharge temperature range	-20°C~45°C (-4°F~113°F)
Charge temperature range	0°C~45°C (32°F~113°F)
Storage ambient temperature	-20°C~45°C (20°C~30°C preferred) [-4°F~113°F(68°F~86°F preferred)]

*Whether the product can be charged or discharged is subject to the actual battery pack temperature.

Battery expansion

Power input/output	40-57.6V⚡12A charge (Max.), 24A discharge (Max.)
Nominal energy	614Wh, support 6 expansion battery packs at most, separate selling.

2. Safety guidelines

2.1 Warning

When using this product, basic precautions should always be followed, including the following:

1. Do not let a working power station be close to the heat source, such as fire or heater.
2. Do not make power station contact with any liquid.
3. Do not use power station in a strong electrostatic or strong magnetic field environment.
4. Do not disassemble power station in any way or pierce it with a sharp object.
5. Do not short power station by wire or other metal objects.
6. It is forbidden to step on, sit or climb on this product.
7. Use of an attachment not recommended or sold by power pack manufacturer may result in a risk of fire, electric shock, or injury to persons.
8. When using power station, please follow the operating temperature defined in this user manual strictly. If the temperature is too high, battery may catch fire or even explode. If the temperature is too low, power station performance will be seriously impaired, even normal use will be impacted.
9. Do not stack heavy objects on power station.
10. Do not stop the fan by force or expose power station in an unventilated or dusty environment when it is working.
11. Please avoid collision, drop, and violent vibration. If severe impact happens, shut down the power supply immediately. Please fix power station firmly during transportation to avoid vibration and impact.
12. If power station falls into water accidentally, place it in a safe and wide area, and keep yourself away from it until it's dry. Dried product shall not be used again. Dispose it properly according to chapter 2.2 in this user manual. If power station is on fire, please use fire extinguishing equipment in the recommended order: water or water mist, sand, fire blanket, dry powder, dioxide carbon fire extinguisher.
13. If there is dirt, use a dry cloth to wipe it.
14. Place power station carefully to prevent damage. If power station is tipped over and seriously damaged, turn off power station immediately and place the battery in a spacious place and keep it away from flammable materials and people, and scrap it in accordance with the requirements of local laws and regulations.
15. To reduce the risk of injury, close supervision is necessary when the product is used near children.
16. Keep power station in a dry and ventilated place.
17. In humid environment (seaside, water, etc.), it is recommended to equip power station with moisture-proof bag. If water is found inside product, do not use/start it again. Please take countermeasures to prevent electric shock before touching power station. Put it in a safe and waterproof open area, and contact customer service immediately.
18. It is not recommended to use power station to supply power for safety-related emergency medical equipment, including but not limited to medical grade breathing machine (hospital version CPAP: Continuous Positive Airway Pressure), artificial lung (ECMO, Extracorporeal Membrane Oxygenation). It can be used to supply power for home version CPAP at home and does not require continuous professional monitoring. Please follow your doctor's advice and consult the manufacturer for any restrictions on the use of the device. For general medical equipment, please pay attention to the power condition to ensure that power does not run out.

19. Power supplies will inevitably generate electromagnetic fields when it is in use, which might affect the implantable medical device or normal operation of personal medical device, such as pacemaker devices, cochlear implants, hearing AIDS, defibrillators, etc. If any of these medical devices are used, please consult the manufacturer about the restrictions on the use to ensure that power station is operated at a safe distance from implanted medical devices such as pacemakers, cochlear implants, hearing AIDS, defibrillators, etc.

20. When the power station is connected to a refrigerator, it may automatically shut down because of the power fluctuation property of the refrigerator. When connecting the power supply to a refrigerator that stores medicine, vaccines or other valuable items, it is recommended to set the AC output to "Never off" in the APP, so as to ensure continuous power. Users should pay attention to power consumption.

21. During the push-pull movement of this product, it is forbidden to put other items on this product.

22. Warning: Operation of this equipment in a residential environment could cause radio interference.

23. Do not put fingers or hands into the product.

24. To reduce risk of damage to the electric plug and cord, pull the plug rather than the cord when disconnecting the power pack.

25. Do not use a battery pack or appliance that is damaged or modified. Damaged or modified batteries may exhibit unpredictable behavior resulting in fire, explosion or risk of injury.

26. Do not operate the power pack with a damaged cord or plug, or a damaged output cable.

27. Do not disassemble the power pack, take it to a qualified service person when service or repair is required. Incorrect reassembly may result in a risk of fire or electric shock.

2.2 Discard

1. Conditions permitting, be sure to discharge the battery completely, and then put power station in the specified battery recycling bin. Power station contains batteries, which are dangerous. It is strictly prohibited to discard them in ordinary dust bins. For details, follow local laws and regulations on battery recycling and disposal.

2. If the battery cannot be discharged completely due to product failure, do not discard the battery directly in the battery recycling bin. Contact a professional battery recycling company for further disposal.

3. The battery will not start after over discharge. Please dispose it as discarded.

3. Guideline for users

3.1 Product overview

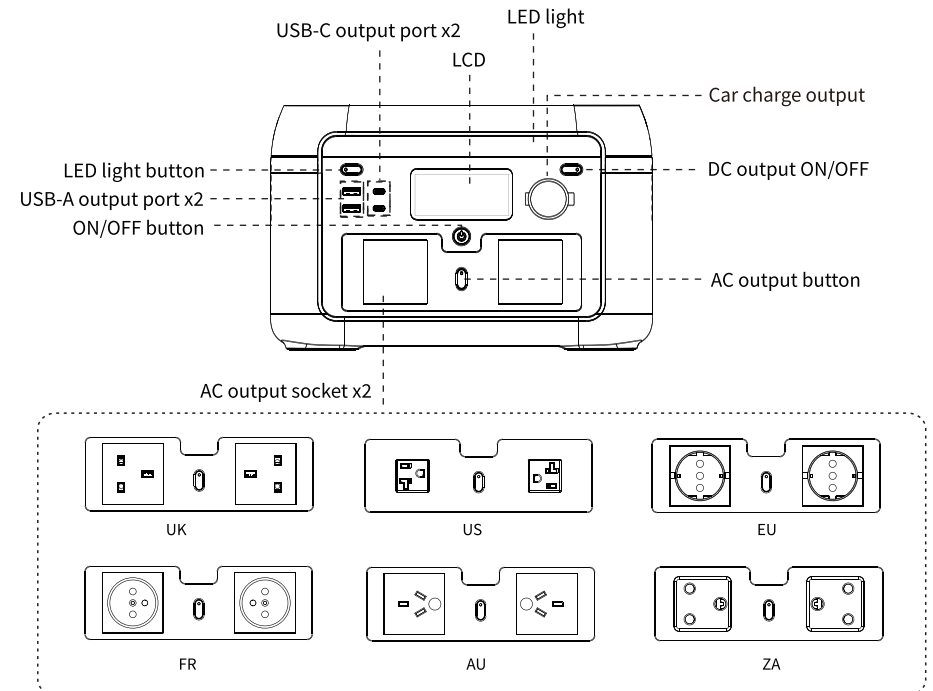

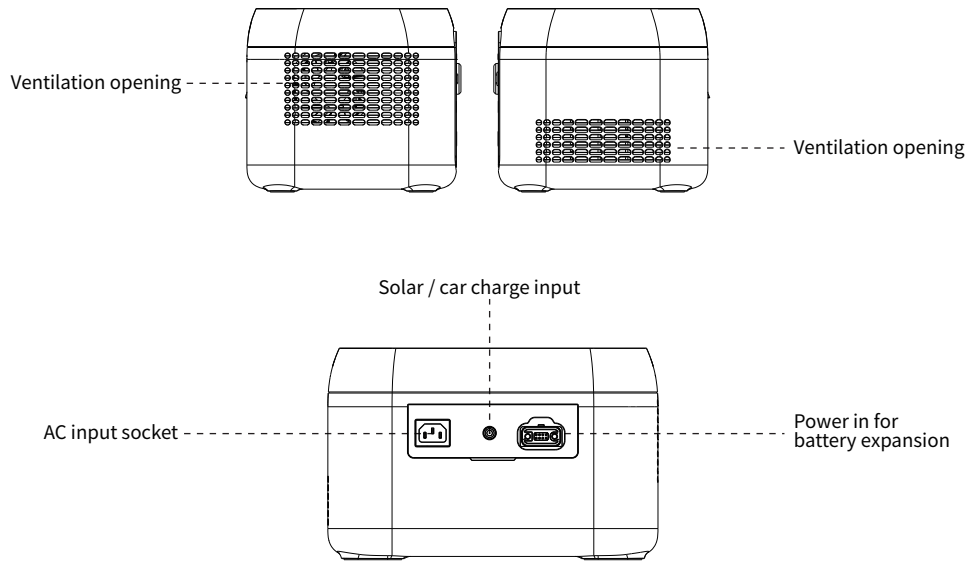

3.2 LCD screen

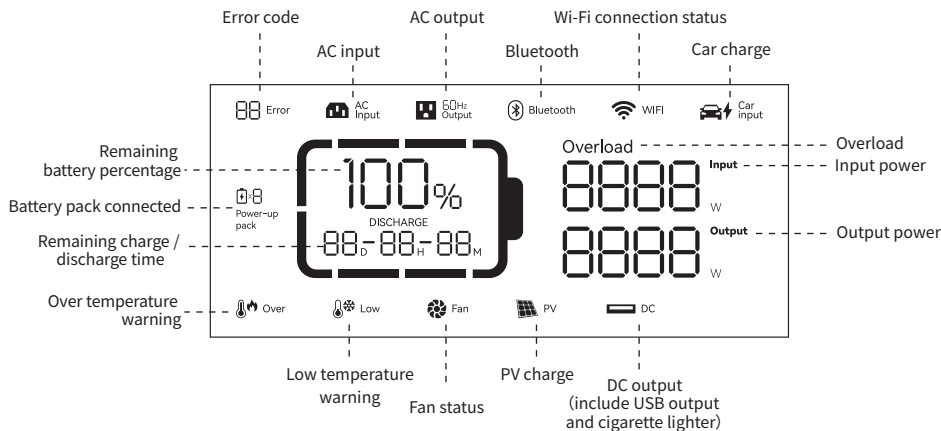

Battery capacity: When power station is being charged, SOC icon will flicker.

Wi-Fi connection status: When wifi reset, wifi icon will flash for 3s, wifi icon light up when wifi link, wifi icon go out when wifi disconnect.

Bluetooth connection status: The Bluetooth icon lights up when this product is matched wirelessly. The Bluetooth icon lights up when the Bluetooth link is successful. Bluetooth icon goes out when Bluetooth is disconnected.

* Please refer to clause 5 for more details regarding error message.

3.3 Use

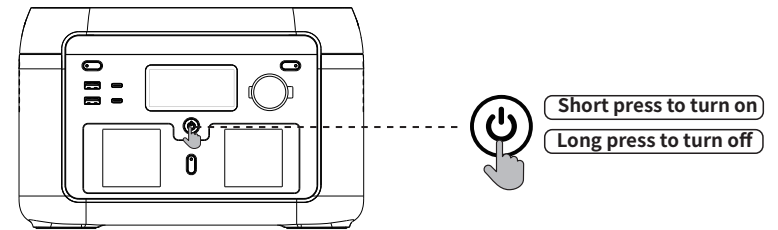



On and off

- Press the main power switch to turn on the device, then the screen will be lit and the main power indicator light will light up.
- When this product lasts for 5 minutes without any operation, the LCD display will be automatically extinguished. When this product is plugged in and unplugged from mains, pv, car charger or key operation, the LCD display will be lit up automatically. To turn on or off the LCD display, press the main power switch.
- Press and hold the main power switch will turn off power station.
- In the normal mode (the power is above 5%), the default standby time of this product is 2 hours; when the AC output switch is not turned on, and there is no charge or discharge for 2 hours, the product will automatically shut down, and the standby time can be Set it on the APP; when the power is 5% or below, the product will be forced to enter the low power mode. In the case of no charge or discharge, the product will adjust the standby time according to the power and automatically shut down.

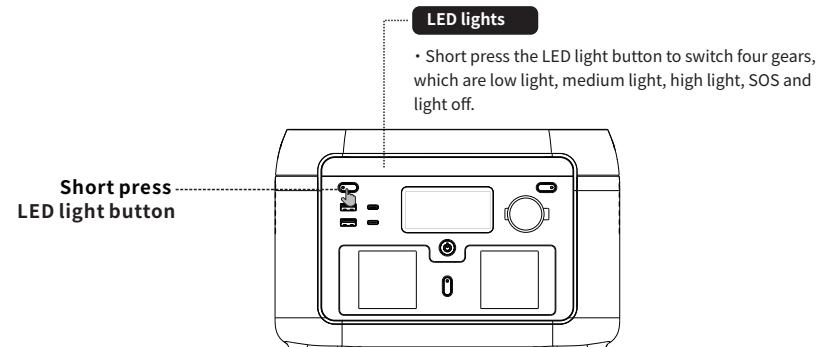
- In normal mode, long press the LED light button to exit the automatic shutdown setting, and the battery icon on the screen will flash. Long press again to enter the automatic shutdown setting, and the battery icon does not flash. (The automatic shutdown setting is to protect the battery from low power, exiting this setting may damage the battery life, please use it with caution.)



Note: When no AC input, long press the above AC output button, you can switch the AC off-grid output frequency ( / ), long press 2s to switch, the AC output icon will flash 3 times after successful switching.

USB output

USB output is enabled by default after the main power switch is turned on.

- After the main power switch is turned on, press the 12V DC output power switch to enable the DC output port.
- Press the 12V DC output power switch again to turn it off.

12V DC output

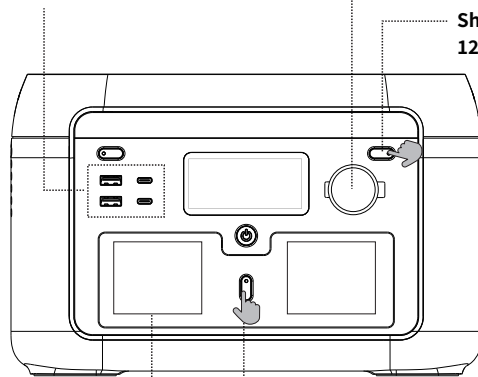

Short press
12V DC output power switch

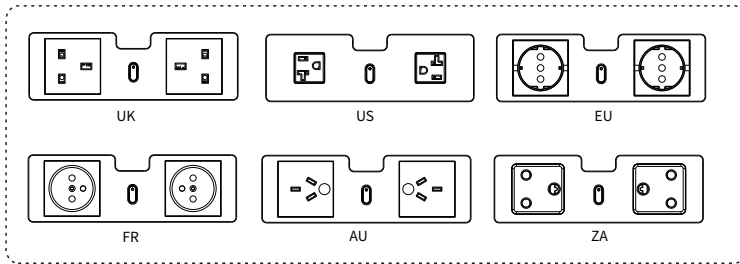

Short press AC output power switch



AC output

- After ensuring that the main power is turned on, short press the AC output power switch to turn on the AC output. Short press the AC output power switch again to turn it off.
- The default standby time of the AC output port is 1 hour. After 1 hour without any load on the AC output port of this product, the AC output power will be automatically turned off. In normal mode, long press the LED light button, the AC output power switch can exit the automatic shutdown setting, and the battery icon  on the screen will flash. Long press again, the AC output power switch enters the automatic shutdown setting, and the battery icon  does not flash.
- Long press the LED light button to exit the AC automatic shutdown setting: it is applicable to AC equipment below 10W and pulse working equipment.
- When the AC output is not in use, turn it off to save power consumption.

3.4 AC charging

When the product is turned on, the default fast charging mode is working. If your product has a wifi function, you can control the recharge rate through the APP.

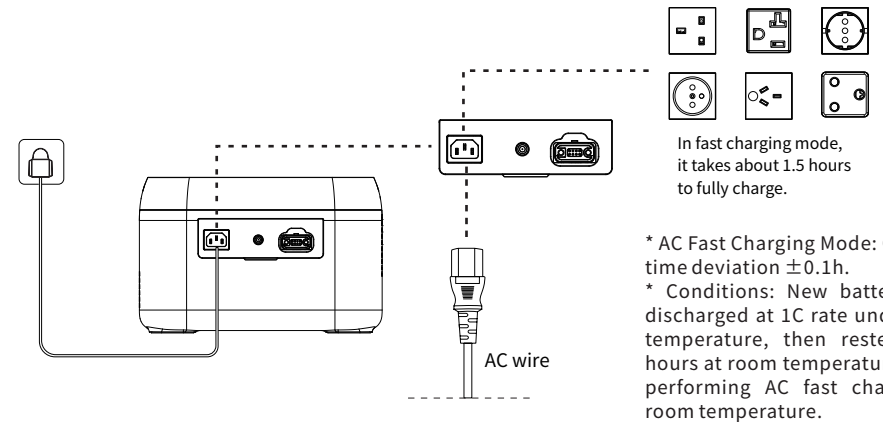

Please use the standard AC cable for charging. AC charging cable should directly plug into 10A (or above) wall-mounted socket. We take no responsibilities for any damage caused by using unofficial AC charging cable, and other failures to follow instructions.

3.5 PV charging

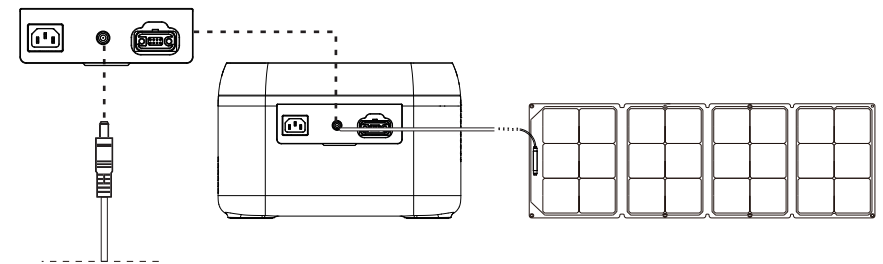

Charge the power station by solar panel.

*Solar charging cable (DC7909)

- Please follow the user manual to connect the solar panels.
- Before connecting the solar panel, check whether its output voltage is within power station specifications to avoid damage to power station.
- *The interface of this product is DC7909. If you need an adapter cable from MC4 to DC7909, please purchase it yourself.

3.6 Car charging

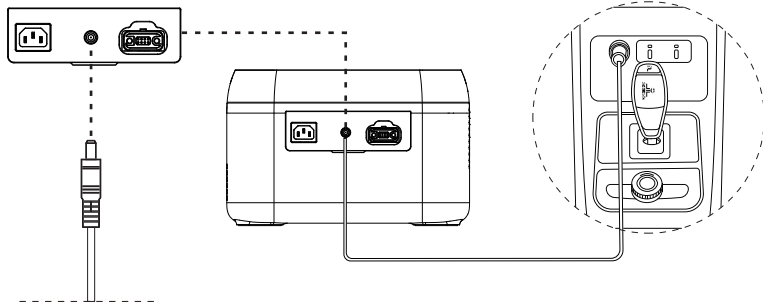

*Car charger cable (DC7909)

Power station can be charged by a car charging port. It should be charged after the car starts, so as to avoid the car battery loss and failure to start. At the same time, ensure good connection between the car charging port and cigarette lighter. We take no responsibilities for any loss caused by improper operation.

3.7 Battery expansion

Power station supports connection with 6 expansion battery packs at the same time for larger capacity. Please refer to the user manual of battery pack for details.

Notes

1. Before connecting the battery pack, please make sure both power station and battery pack are off.
2. After the battery pack is connected, check if battery icon is shown in the displays of both power station and battery pack.
3. While in charging, please do not connect or remove the battery pack. If connection or need to connect or remove it, turn off power station prior to operation.
4. Please do not touch the metal terminals. If there is foreign matter on the metal terminals, clean it with a dry cloth gently and carefully.

Parallel mode of 1 power station and 1 expansion battery pack:

- 1 Turn off the power station and expansion battery pack.
- 2 The expansion cable plugs into the expansion port of the power station and the Power Input/Output of the expansion battery pack.
- 3 After parallelization, press power button  of power station to enable the power station and battery pack to show current capacity. The power station shows the paralleled quantity, and capacity is expanded.
- 4 After parallelization, connect ports of the power station for charging or discharging (refer to clause 3.3, 3.4, 3.5 and 3.6).

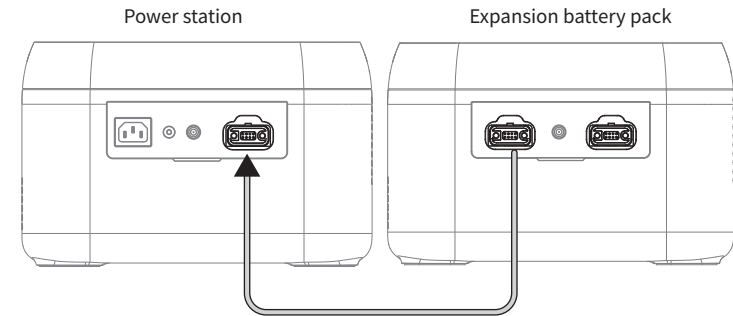

Notes

Both ports of the expansion battery pack can be connected to the expansion port of the power station.

Both ports of the expansion cable can be connected to the ports of the expansion battery pack and the expansion port of the power station.

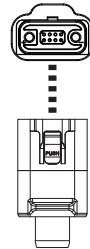

Parallel mode of 1 power station and multiple expansion battery packs:

- 1 Turn off the power station and expansion battery packs.
- 2 The expansion cable plugs into the expansion port of the power station and the Power Input/Output of expansion battery pack 1, the Power Input/Output of expansion battery pack 1 connects to the Power Input/Output of expansion battery pack 2, the Power Input/Output of expansion battery pack 2 connects to the expansion battery pack 3. 6 battery packs can be parallelized at most.
- 3 After parallelization, press power button  of the power station to enable the power station and battery packs to show current capacity. The power station shows the paralleled quantity, and capacity is expanded.
- 4 After parallelization, connect ports of the power station for charging or discharging (refer to clause 3.3, 3.4, 3.5 and 3.6).

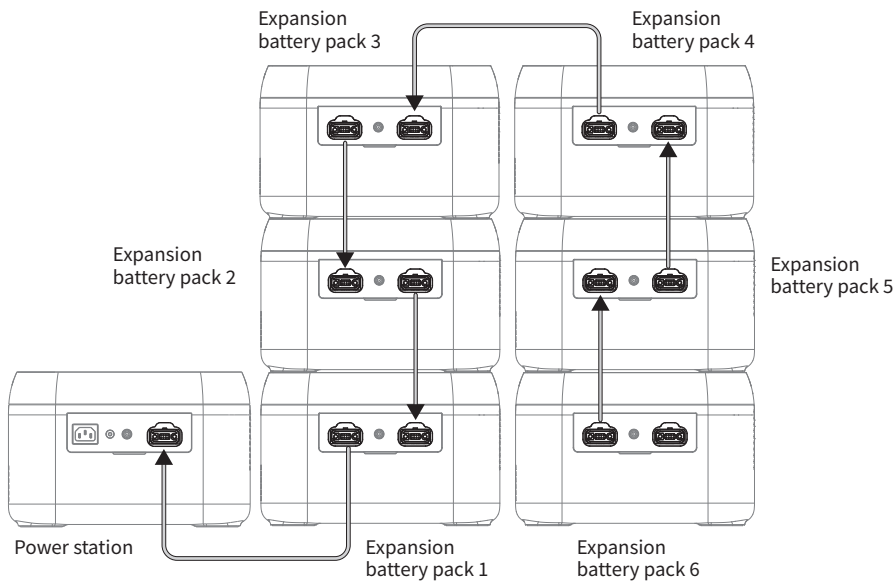

Notes

Both ports of the expansion battery pack can be connected to the expansion port of the power station.

Both ports of the expansion cable can be connected to the ports of the expansion battery pack and the expansion port of the power station.

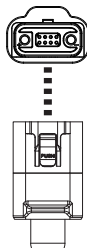

3.8 Constant power

With the constant power output function, you can use the product to power appliances that exceed the rated power of the device without disruption caused by overload protection. When the power supply needs to drive high-power electrical appliances, the inverter will intelligently regulate the output power of the power supply to maintain a constant actual output power, ensuring that the electrical appliances can still operate reliably.

Please take note of the following when using the constant power output function:

1. The constant power output function is not enabled by default, which can be turned on or off by App.

2. In the following cases, constant power output function is not enabled:

(1) AC output is turned on in charging status (bypass mode).

(2) Constant power output function is turned off.

3. When using an appliance that exceeds rated power of the device, please connect only one appliance. When connecting more than one electrical appliance, the change of voltage may affect the usage of other electrical appliances.

4. Constant power output function is more suitable for heater and motor instead of all electrical equipment. It is not suitable for some electrical appliances with voltage protection (such as precision instruments). Constant power output function application is subject to actual testing.

3.9 APP

You can control and view information and data about this product by App.

Software download, search for [Smart Life] in the Google App Store or Apple App Store, download the software, register and open it or scan the QR code below to download. For detailed usage of the APP, please refer to the APP Operation Guide.



3.10 EPS function

This product supports the EPS (emergency backup power) function. You connect the power grid and the AC input port of this product through the AC charging cable; Bypass mode (AC power comes from the grid, not the battery); when the grid suddenly loses power, the product can automatically switch to battery power supply mode within 10mS, at this time it is an inverter mode (AC power comes from the battery, not the grid). This function does not support 0mS switching. Please do not connect it to devices that require high uninterrupted power supply, such as data servers and workstations, or use it after multiple tests to confirm whether it is compatible, and it is recommended to use only one device during use, and do not use multiple devices at the same time to avoid overload protection of the product. If the device does not operate normally or data is lost due to failure to follow the instructions, our company will not bear the corresponding responsibility.

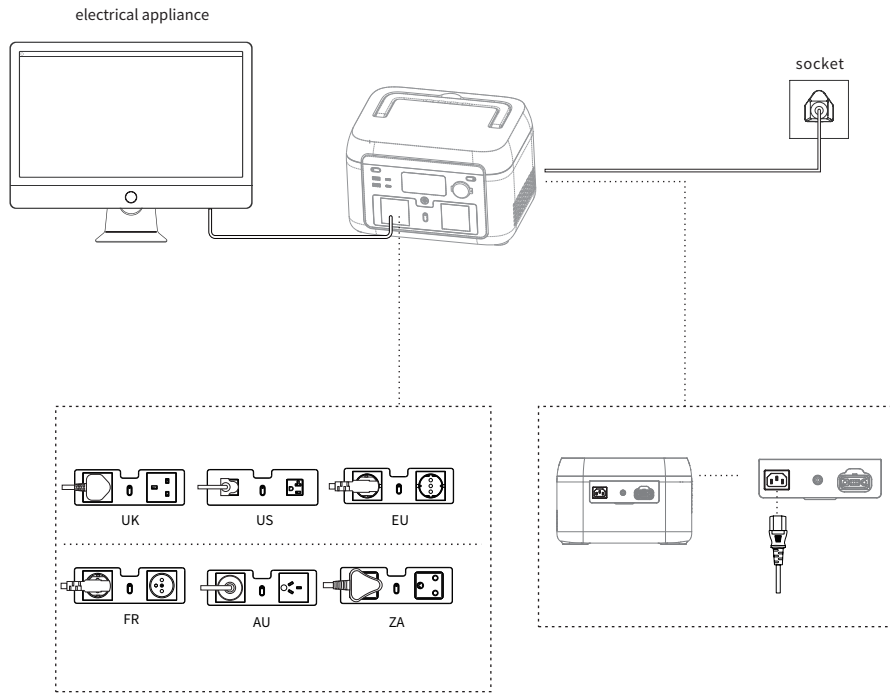

4. FAQs (Frequently Asked Questions)

1. What kind of battery is used?

Lithium iron phosphate battery (LiFePO₄).

2. What equipment can be connected to the AC output ports?

The AC output port of the product has high rated power and the highest power, which can supply power for small power household equipment. We suggest confirming the power of the equipment before use to ensure that the sum of the power of all load equipment is lower than the rated power.

3. How to know the supply time?

Time shows in the LCD, which can be referred to for estimation for equipment with stable power consumption.

4. How to know it is charging?

When in charge, the LCD shows remaining charging time. The SOC flickers, and input power is shown.

5. How to clean the unit?

Clean the unit with a dry, soft and clean cloth or tissue.

6. How to store the unit?



Turn it off, and keep it in a dry and ventilated place. Do not expose it close to water. For long-term storage, charge and discharge every 3 months, i.e. discharge to 0% then charge to 100%, and then discharge to 48%~52%.



7. Can it be taken on board?

No.

5. Error messages & solutions

Icon	Fault Description	Solution
02 Error Error code always on	Pressure difference is too large	Automatic recovery after fault clearing; 3 consecutive locks within a certain period of time, longer recovery time.
03 Error Error code always on	BMS voltage fault	Auto shutdown, fault will be cleared after reboot.

Icon	Fault Description	Solution
 Over 04 Error High temperature icon always on Error code always on	Battery OTP (over temperature protection) fault	Auto shutdown, fault cleared when temperature is restored.
 Low 05 Error Low temperature icon always on Error code always on	Battery UTP (under temperature protection) fault	
06 Error Error code always on	OCP (over current protection) fault	Remove the over-power device, and it will automatically recover after the fault is cleared; if it is triggered continuously for 3 times within 1 minute, it will be locked, and the recovery time will be prolonged, and it can be recovered by powering on and off again.
 Over 07 Error High temperature icon always on Error code always on	BMS board over temperature fault	Auto shutdown, delayed start.
08 Error Error code always on	Abnormal precharge	Power on and off again to clear the fault.
09 Error Error code always on	Battery under voltage fault	charging process, Repeated charging failures or failure to charge, please contact customer service.
11 Error Error code always on	Abnormal INV battery voltage	Automatic recovery after the fault is cleared; if it is triggered 3 times within 1 minute, it will be locked, and the recovery time will be extended, and it can be recovered by powering on and off again.
12 Error Error code always on	Grid voltage or frequency fault	The fault is cleared when the grid returns to normal.
13 Error Error code always on	Abnormal INV BUS voltage	Automatic recovery after the fault is cleared; if it is triggered 3 times within 1 minute, it will be locked, and the recovery time will be extended, and it can be recovered by powering on and off again.
14 Error Error code always on	Abnormal INV output	
Overload 15 Error Overload icon always on Error code always on	INV discharge overload	Remove the over-power device, and it will automatically recover after the fault is cleared; if it is triggered continuously for 3 times within 1 minute, it will be locked, and the recovery time will be prolonged, and it can be recovered by powering on and off again.
Overload 16 Error Overload icon always on Error code always on	Charge overload	Automatic recovery after the fault is cleared; if it is triggered 3 times within 1 minute, it will be locked, and the recovery time will be extended, and it can be recovered by powering on and off again.

Icon	Fault Description	Solution
17 Error Error code always on	INV Tz	Auto recover after fault is cleared.
 Over 20 Error High temperature icon always on Error code always on	MOSFET OTP fault	After removing the device and restarting, the fault is cleared.
21 Error Error code always on	Fan stop	Exclude the fan abnormality, turn on and off, contact after sales if still not fixed.
23 Error Error code always on	Charge soft start fault	Automatic recovery after the fault is cleared; if it is triggered 3 times within 1 minute, it will be locked, and the recovery time will be extended, and it can be recovered by powering on and off again.
24 Error Error code always on	MOSFET UTP fault	Automatic recovery after the product heats up.
27 Error Error code always on	DC input hardware overcurrent protection	Remove DC charge, auto recover after connecting DC and turn on.
28 Error Error code always on	DC input software overcurrent protection	DC charging stops and will automatically resume after the fault is eliminated.
31 Error Error code always on	PV output OVP (over voltage protection) fault	Removing the PV charging interface will automatically restore it after a certain period of time.
32 Error Error code always on	DC input voltage overvoltage protection	Remove the DC charging interface for a certain period of time to automatically recover or check whether the DC output fuse is disconnected.
 Over 35 Error High temperature icon always on Error code always on	DC input over temperature protection	Stop DC. Auto recover after fault is cleared.
 Over 37 Error High temperature icon always on Error code always on	Car charge output OTP fault	Turn off output, manual recover after fault is cleared.
38 Error Error code always on	Abnormal communication	Turn on and off, or change operation environment. Contact after sales if still not fixed.
43 Error Error code always on	The battery voltage is too low. The battery is broken	Contact after-sales processing.

If there is a warning occurs during the use of this product, and the warning icon still does not disappear after restarting the device, please stop using it immediately (do not try to charge or discharge).

If none of the above information can solve problem you encounter, please contact the customer service for consultation.

Note: Both PV and Car Charger are DC input sharing the same DC Ports.

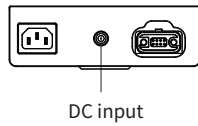

6. What's in the box

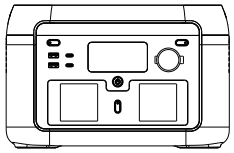

Power station

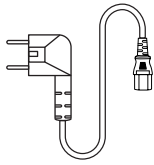

AC cable

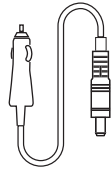

Car charge cable

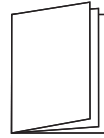

User manual

7. Maintenance

- It is recommended to use or store power station under 20~30°C ambient temperature. Keep it away from water, heater and metal parts.
- For long-term storage, charge and discharge every 3 months, i.e. discharge to 0% then charge to 100%, and then discharge to 48%~52%.
- For safety, do not store power station with temperature above 45°C or below -10°C.
- If the capacity is lower than 1%, please charge to 60%. Long-term storage with serious power shortage will cause irreversible damage to the cell and shorten the service life of the product.
- If the capacity is seriously insufficient and idle time is too long, the product will enter deep sleep mode, and the product can only be used after being charged.
- After charging or discharging this product, you must wait for more than 30 minutes before using it.

8. Disclaimer

- The product has a built-in battery management system, which has protections such as overcharge, overdischarge, overcurrent, short circuit, high and low temperature, and abnormal communication. During the use of this product, protection may occur and cause output interruption. Power supply to special equipment, such as medical equipment, server, the indirect loss caused by accidental power failure has nothing to do with the company; all accidents caused by illegal use, self-dismantling, and man-made damage have nothing to do with the company.
- Before using the power station, please read this user manual to ensure understanding and proper use. After reading the user manual, please keep it well for future reference. Improper operation may cause serious injury to yourself or others, or result in product damage and property loss. Once using power station, you are deemed to have understood and accepted all terms and contents herein. Users promise to be responsible for their actions and all consequences arising therefrom. We shall not be liable for any loss arising from user's not following this user manual.
- In compliance with laws and regulations, the company reserves the right of final interpretation of this document and all related documents of this product. Subject to update, revision or termination without prior notice, please visit the official website for the latest product information.